

20.50.1702.00

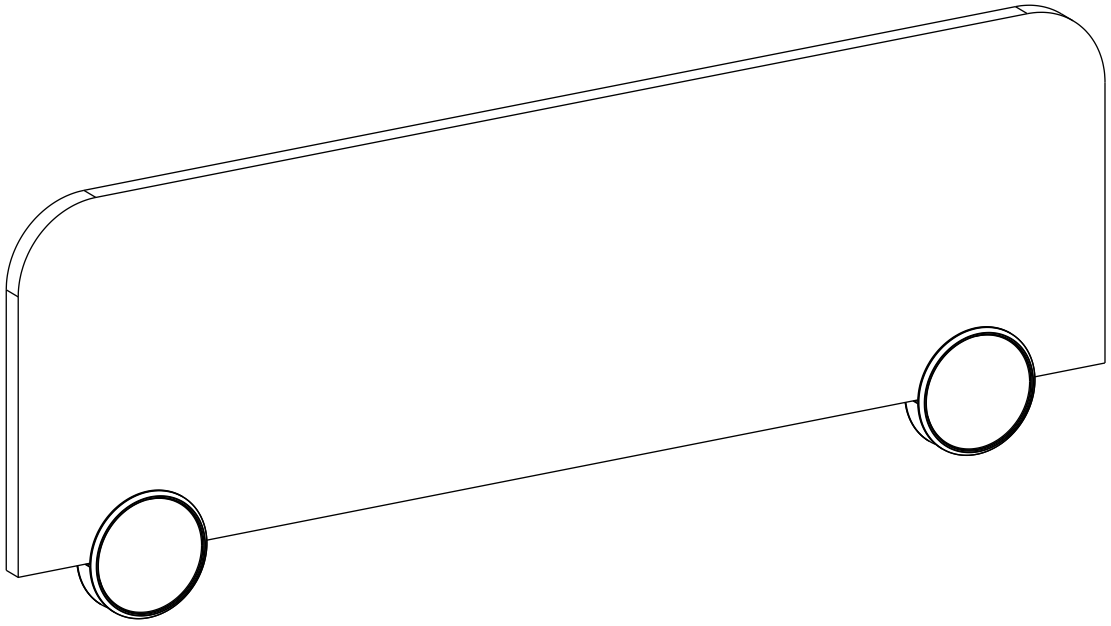

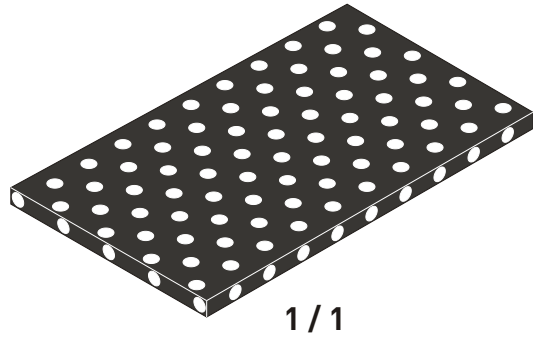

1/1

1/1

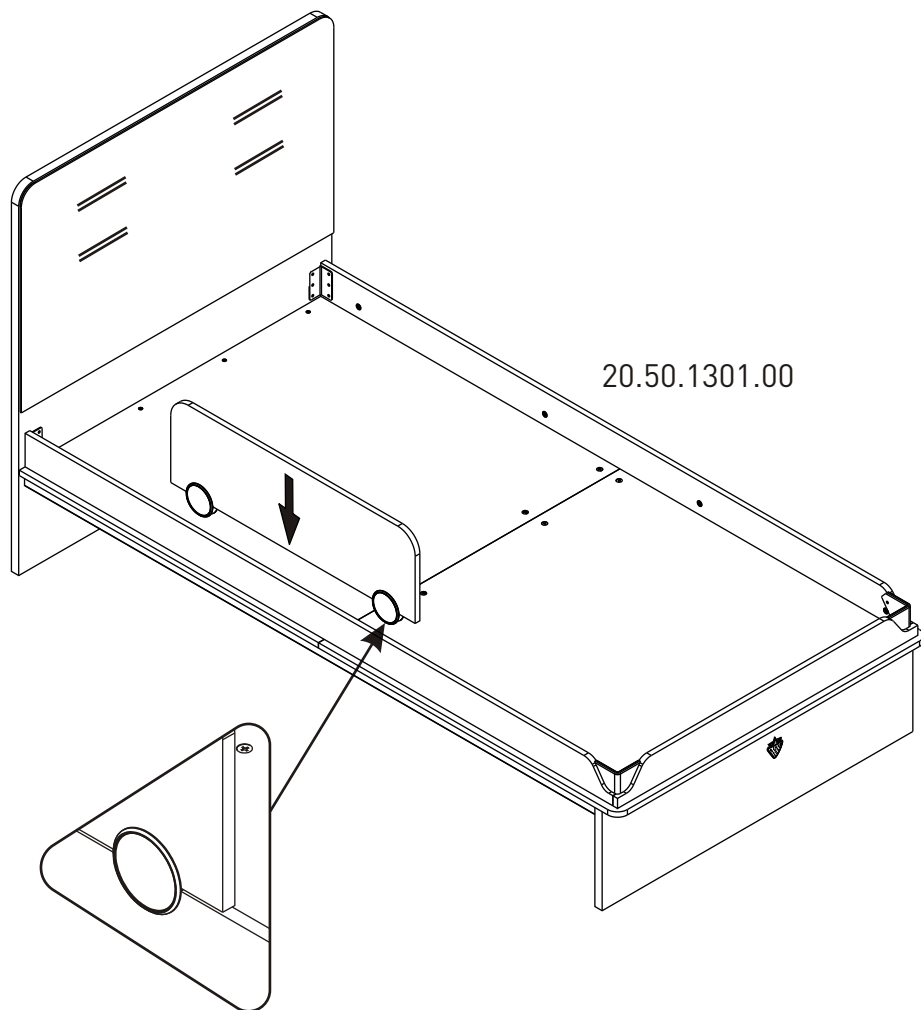
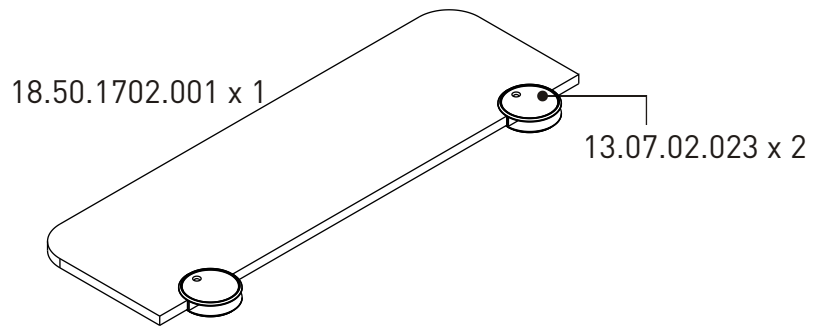

1